

# Direct Drive Centrifugal Fan Model 669



**Motor**  
0.55kW

**Weight**  
19Kg

**Phase**  
1 & 3

**Max Inlet Temp**  
40 Deg C

**Max Current**  
3.5 & 1.4 A

**Noise Level**  
71dB(A)

Current readings are based upon voltages of 230V Single Phase and 400V Three Phase

Noise levels have been measured at a distance of 1m from the blower, which was fitted a ducted outlet.

**Picture depicts Model 669**

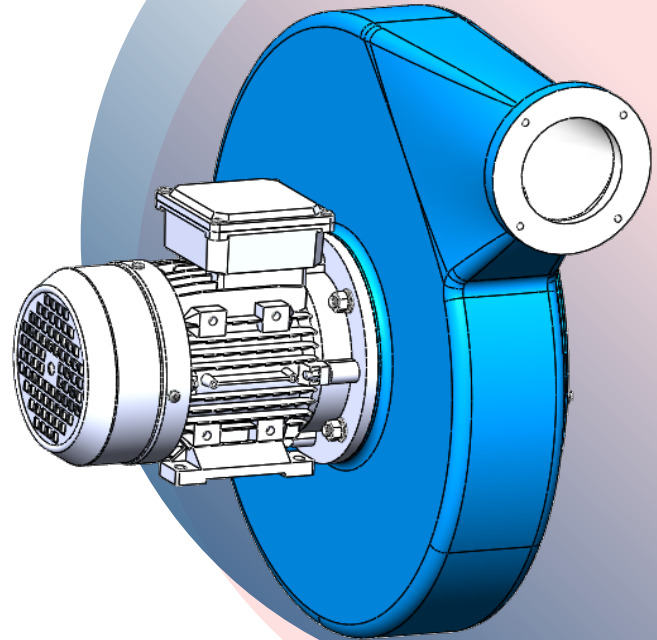

Actual product image may vary for different models

## Performance Curve

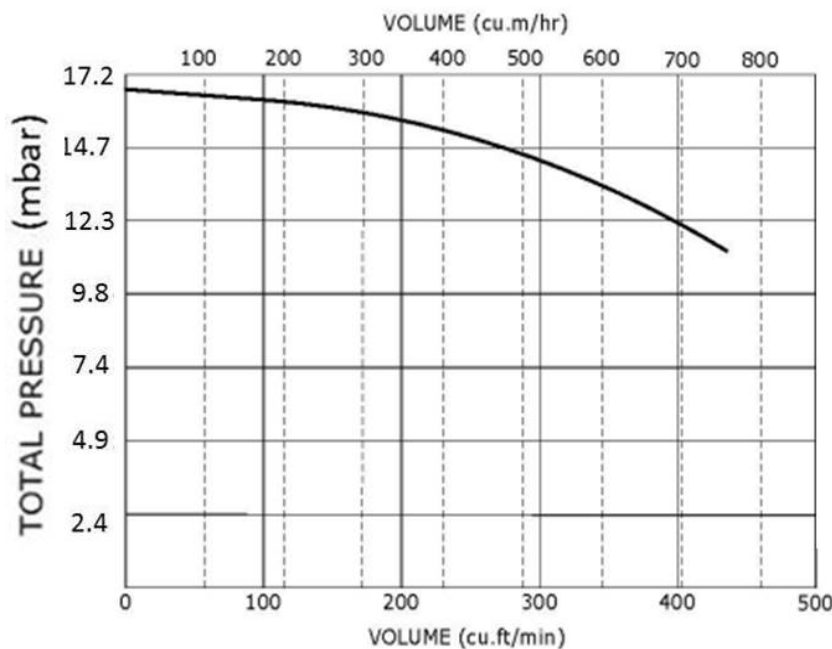

# Direct Drive Centrifugal Fan Model 669



## Technical Drawing : Model 669

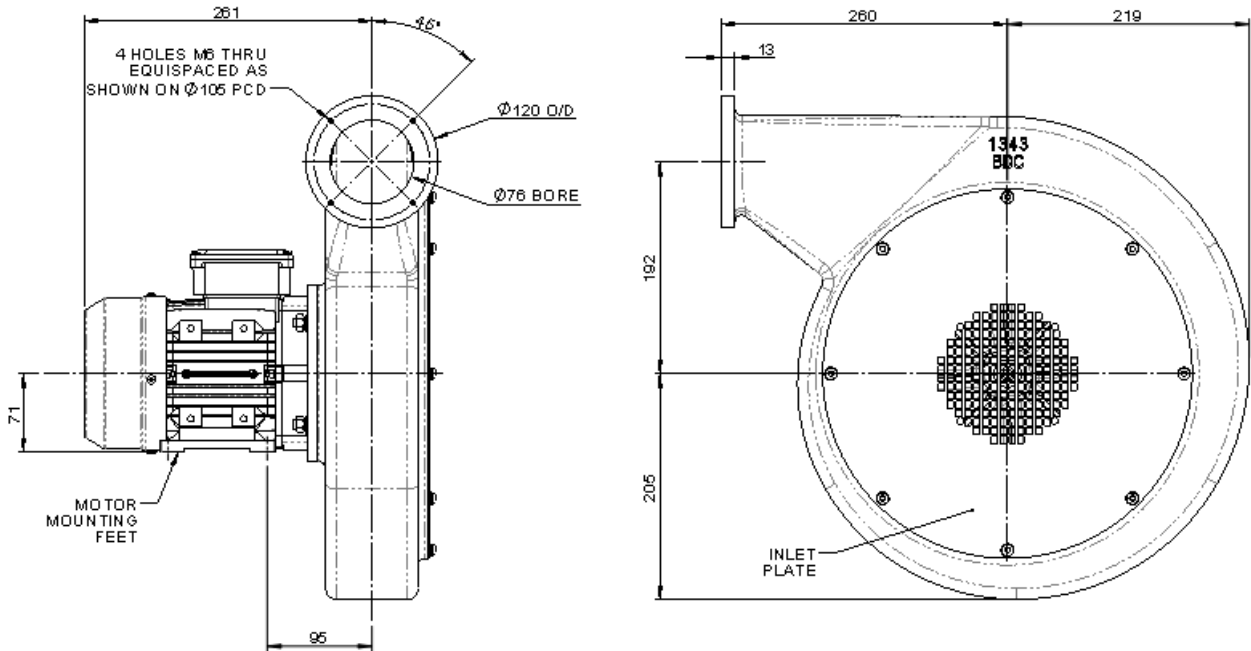

## AVAILABLE FAN HANDINGS

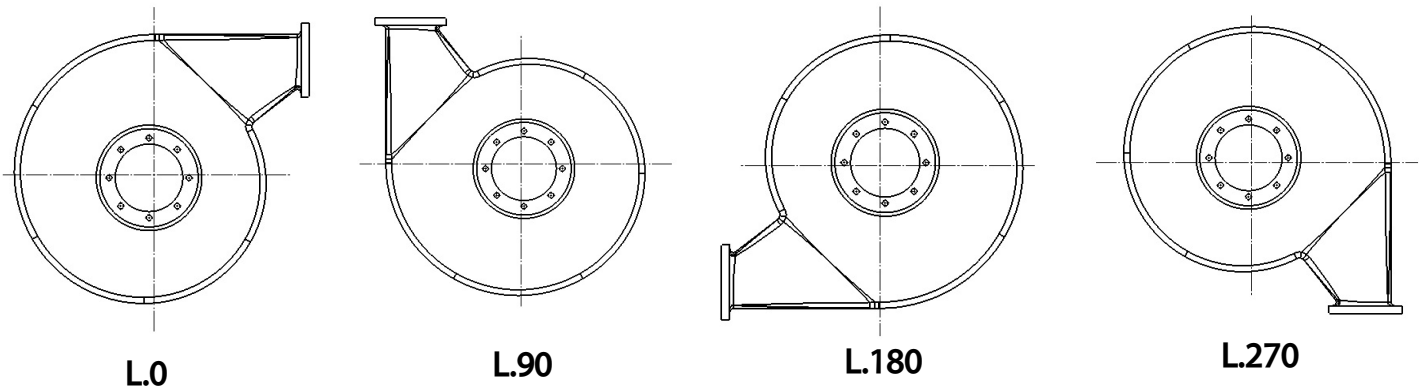

All dimensions in mm