

Model 571/3

INSTANT HEAT FOR DIRECT DRIVE AND HIGH VELOCITY FANS

FEATURES AND BENEFITS

- Up To 300 °C Peak Outlet Temperature
- 3 kW output
- 230 - 250 V
- Single Or Three Phase
- Single Heater Cartridge with up to 3 Elements (3ph)
- No Maintenance
- Stainless Steel Casing
- Direct Fit with DD573 Fan and Compatible with Fan and Blower Range



Product supplied may differ from image based on requested requirements. Image represents Model 571/4 Process Heater (casing / element).

MAXIMUM OUTLET TEMPERATURE: 300 °C

- Resistance to Airflow (approx)
 - 1.2 mbar at 68m³/hr
 - 8.2 mbar at 169.9m³/hr
 - 18.4 mbar at 255m³/hr

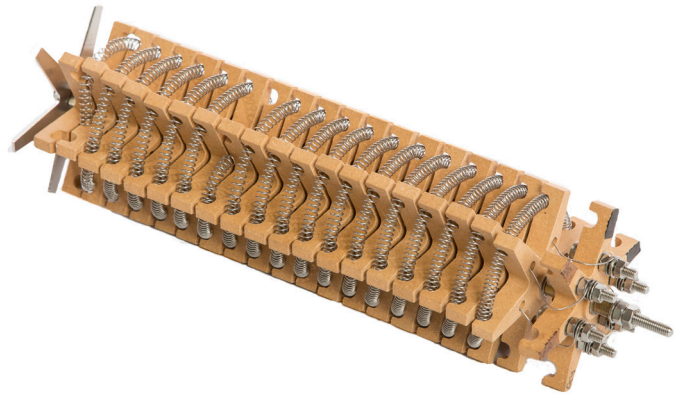

PROCESS AIR HEATER

PERFORMANCE CURVE

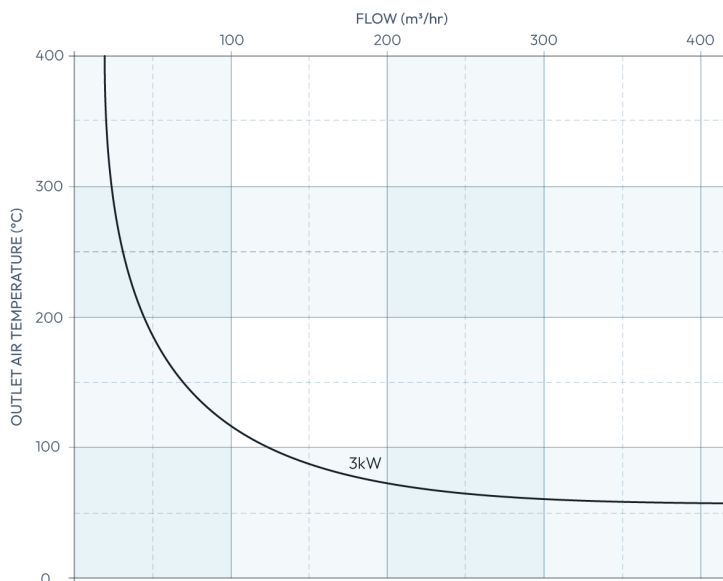

Temperatures calculated based on standard air at 20°C & 1.204 kg/m³ (NTP)

Model 571/3

DIMENSIONAL DRAWING

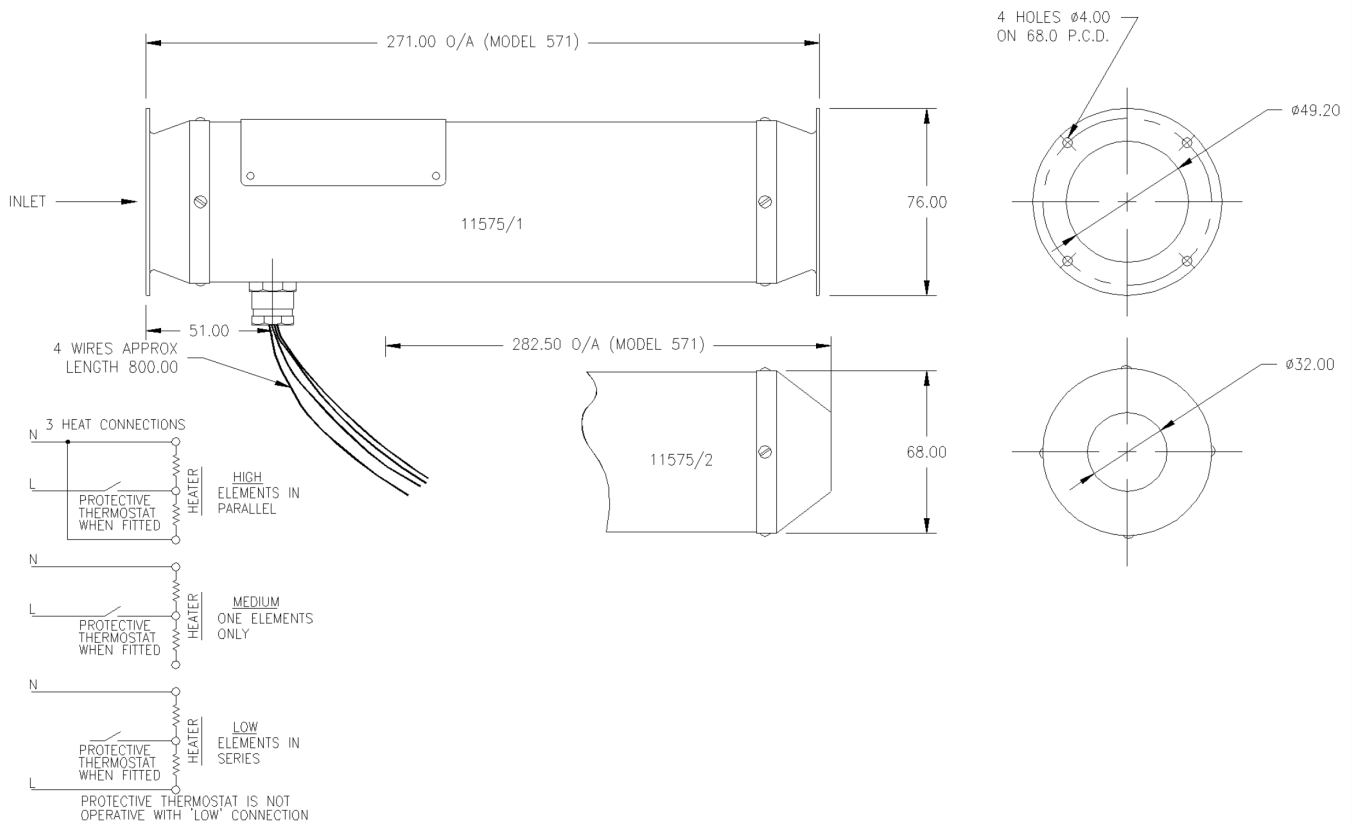

PROCESS AIR HEATER

All dimensions in mm