

Model 632/9

INSTANT HEAT FOR DIRECT DRIVE
AND HIGH VELOCITY FANS

FEATURES AND BENEFITS

- Up To 300 °C Peak Outlet Temperature
- 9 kW output
- No Maintenance
- Stainless Steel Casing with Cool Touch Insulated Outer Jacket
- Temperature Controls Available
- Compatible with Fan and Blower Range
- UL Approved

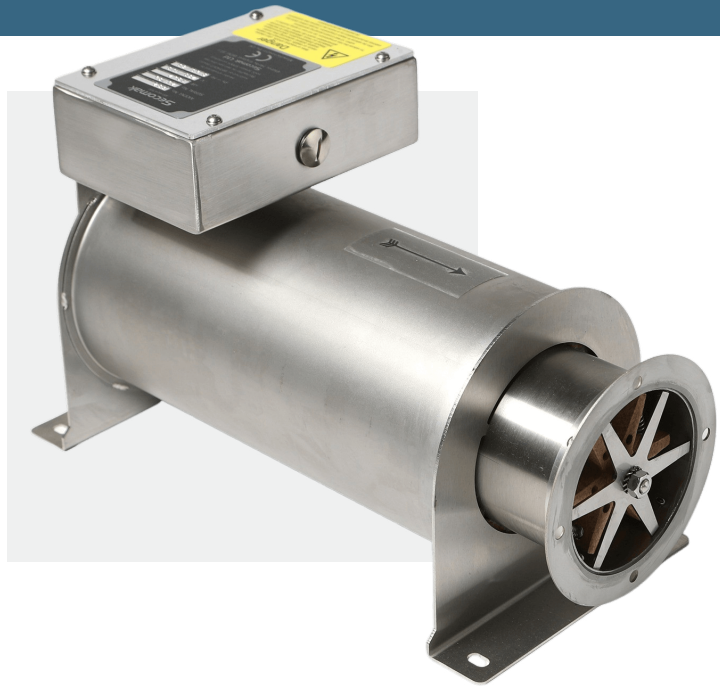

Product supplied may differ from image based on requested requirements. Image represents Model 632 Process Heater (casing / element).

MAXIMUM OUTLET TEMPERATURE: 300 C

- Resistance to Airflow (approx)
 - 0.85 mbar at 169.9m³/hr
 - 4.23 mbar at 339.8m³/hr
 - 25.63 mbar at 509.7m³/hr

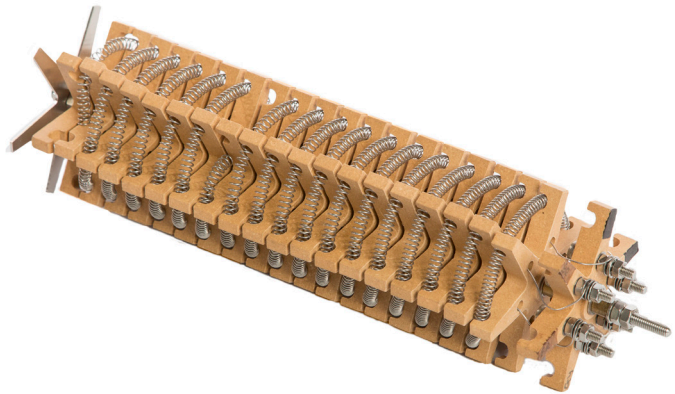

PROCESS AIR HEATER

PERFORMANCE CURVE

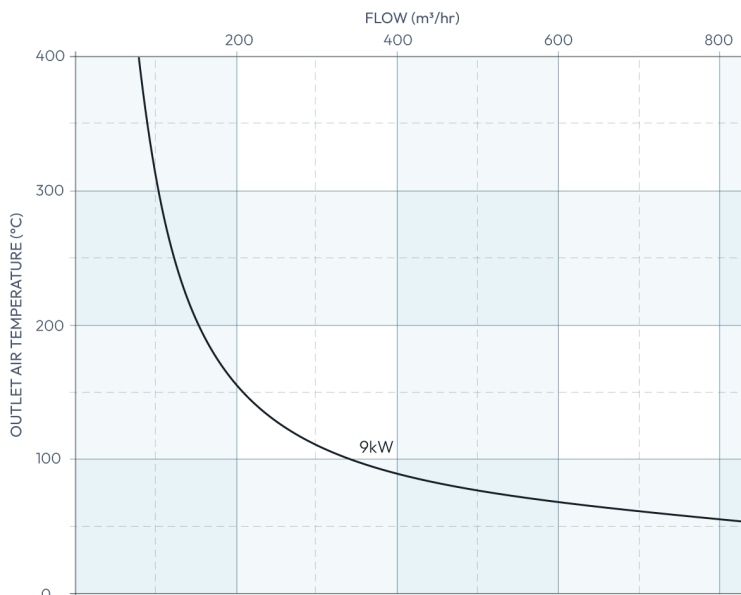

Temperatures calculated based on standard air at 20°C & 1.204 kg/m³ (NTP)

Model 632/9

DIMENSIONAL DRAWING

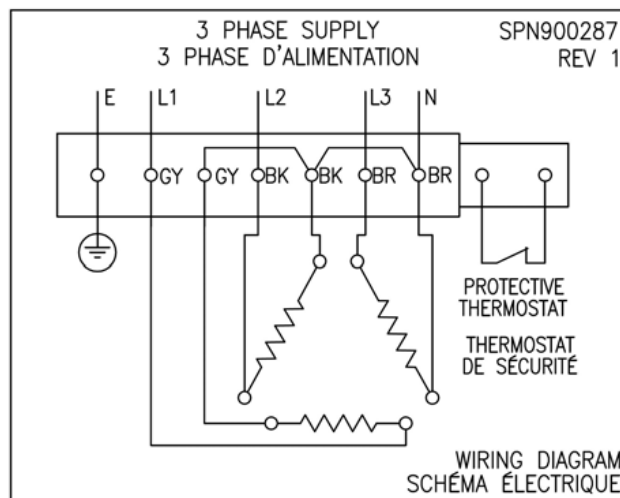
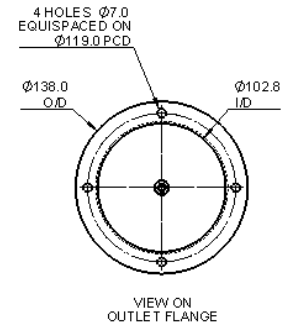
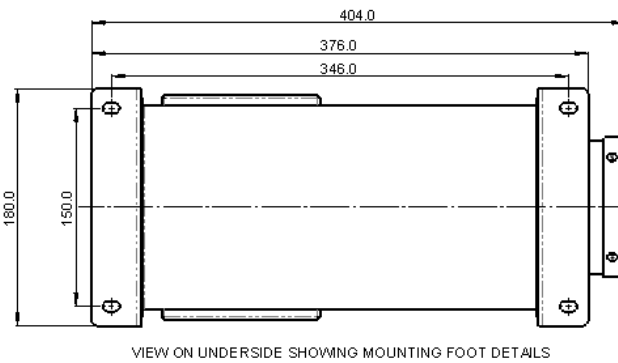
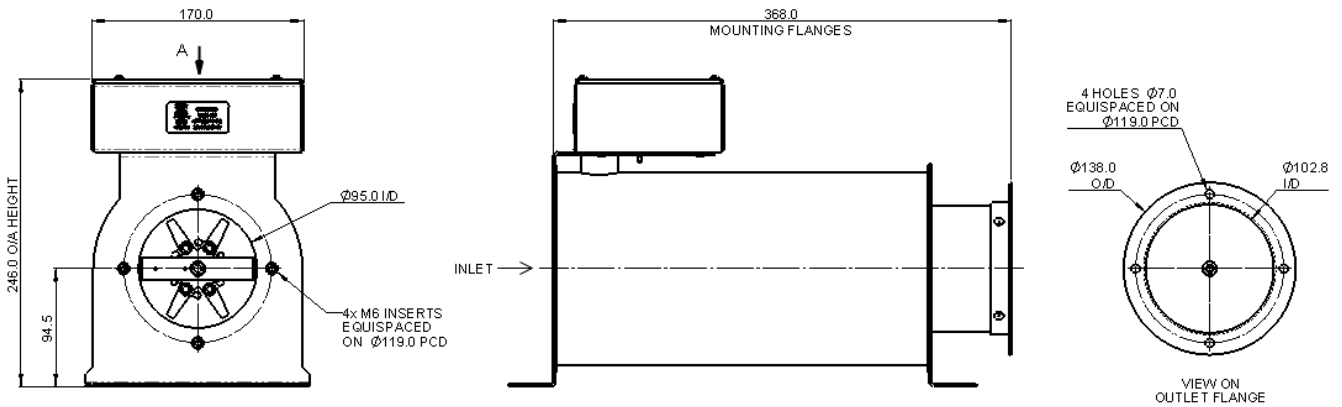

PROCESS AIR HEATER

All dimensions in mm