

## Model 648/24

INSTANT HEAT FOR DIRECT DRIVE AND HIGH VELOCITY FANS

### FEATURES AND BENEFITS

- Up To 300 °C Peak Outlet Temperature
- 24 kW output
- No Maintenance
- Stainless Steel Casing with Cool Touch Insulated Outer Jacket
- Aluminium Terminal Box
- Temperature Controls Available
- Compatible with Fan and Blower Range
- UL Approved

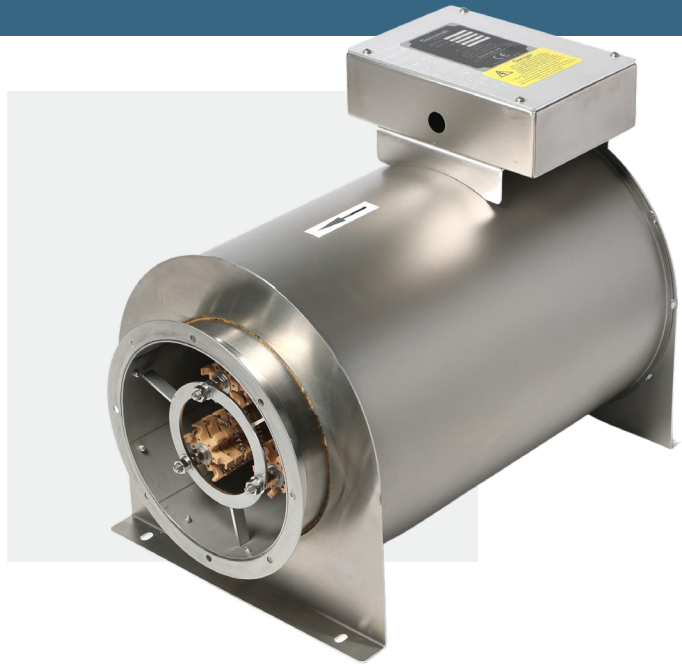

Product supplied may differ from image based on requested requirements. Image represents Model 648 Process Heater (casing / element).

### MAXIMUM OUTLET TEMPERATURE: 300 C

- Resistance to Airflow (approx)
  - 0.55 mbar at 339.8m<sup>3</sup>/hr
  - 8.7 mbar at 1359.21m<sup>3</sup>/hr
  - 26.9 mbar at 2379m<sup>3</sup>/hr

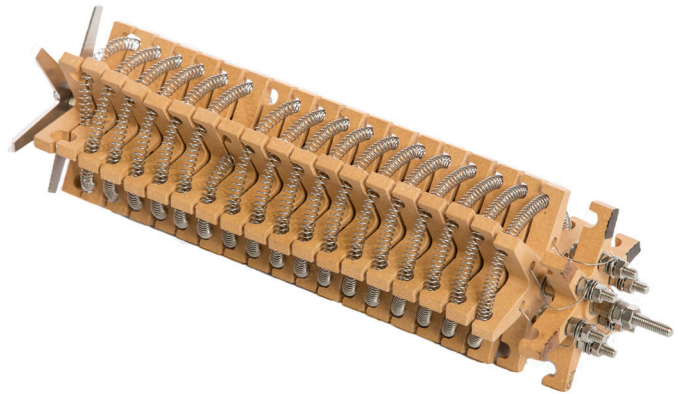

PROCESS AIR HEATER

### PERFORMANCE CURVE

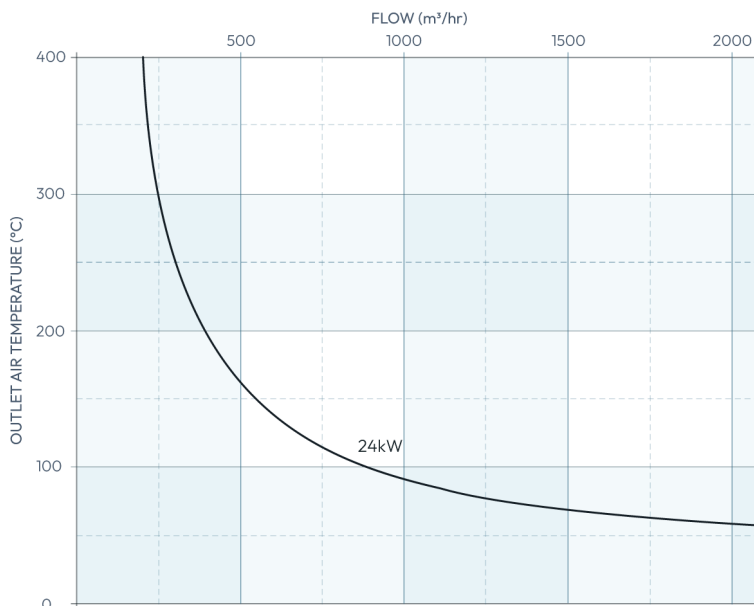

Temperatures calculated based on standard air at 20°C & 1.204 kg/m<sup>3</sup> (NTP)

## Model 648/24

### DIMENSIONAL DRAWING

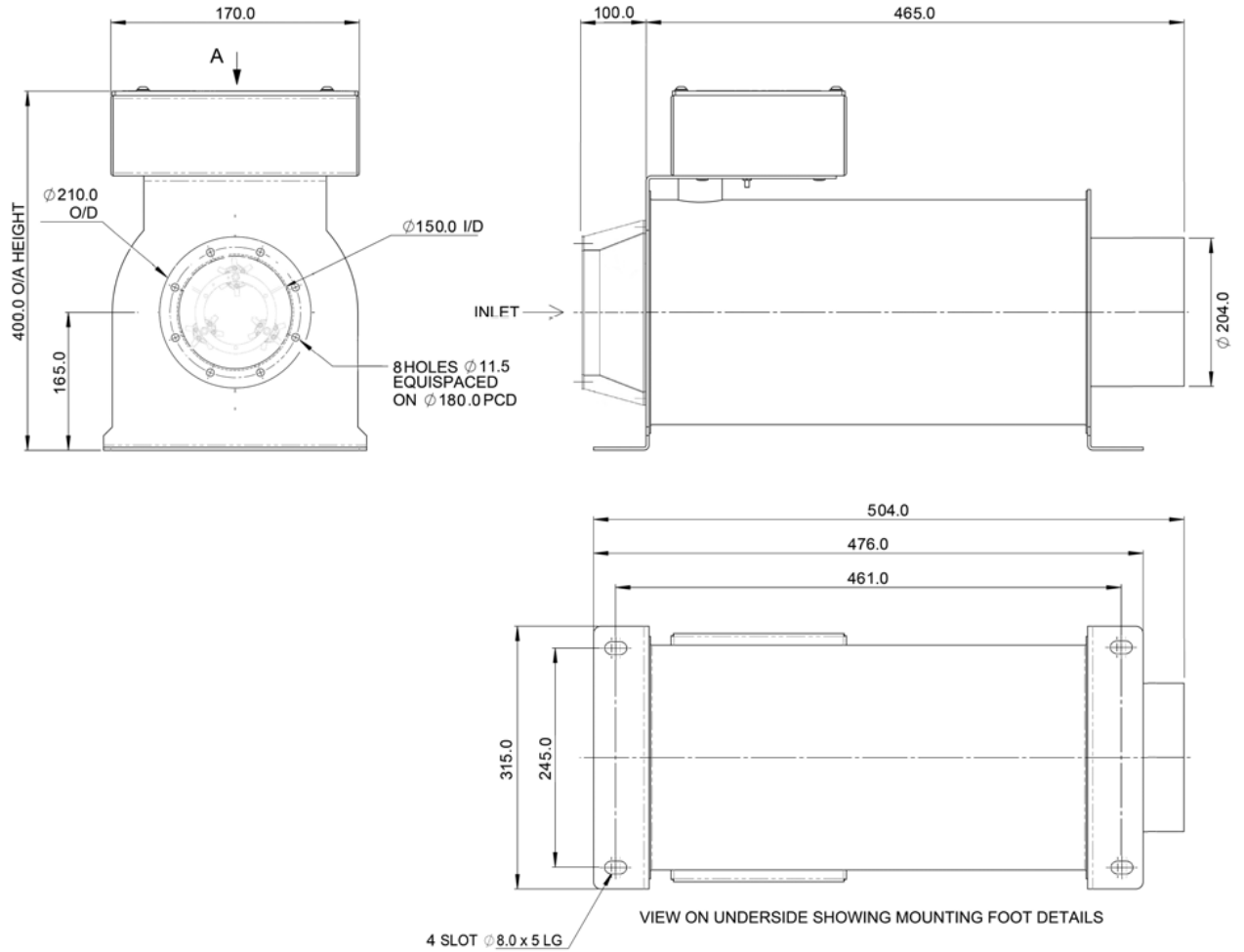

PROCESS AIR HEATER

All dimensions in mm